

Features and Highlights

- World's most energy efficient temperature sensor
0.36 μ J/measurement ($T_A=25^{\circ}\text{C}$, 3.3V)
- Wide temperature range: -45°C to 130°C
- Wide supply voltage range: 2.7V to 5.5V
- High accuracy: $\pm 0.25^{\circ}\text{C}$ (-10°C to 100°C T018)
 $\pm 0.1^{\circ}\text{C}$ (-20°C to 60°C , T018)
- Extreme low noise: 0.0002 $^{\circ}\text{C}$
- Ultra-low current (60 μ A active or 220nA average)
- Excellent long term stability
- Direct interface with Microcontroller (MCU)
- Wide range of package options

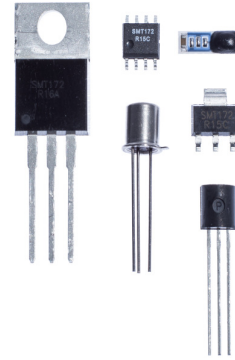

Application

- Ultra-low power applications: wearable electronics, wireless sensor networks
- Medical applications: body temperature monitoring
- Instrumentation: (Bio)chemical analysis, precision equipment
- Environmental monitoring (indoor/outdoor)
- Industrial applications: process monitoring/controlling

Introduction

The SMT172 is an ultra-low power, high-precision temperature sensor that combines the ease of use with the world's leading performance over a wide temperature range. Using the most recent advances in the silicon temperature sensing technology, the SMT172 has applied some really sophisticated IC design techniques as well as high-precision calibration methods, to achieve an absolute inaccuracy of less than $\pm 0.1^{\circ}\text{C}$ in the range of -20°C to 60°C

The SMT172 operates with a supply voltage from 2.7V to 5.5V. The typical active current of only 60 μ A, the high speed conversion over 4000 outputs per second (at room temperature) and an extremely low noise makes this sensor the most energy efficient temperature sensor in the world (0.36 μ J/measurement).

The SMT172 has a pulse width modulated (PWM) output signal, where the duty cycle is proportional to the measured temperature. This makes it possible that the sensor can directly interface to a MCU without using an Analog-to-Digital Converter (ADC). Today, the hardware Timer in a MCU to read our PWM signal has become available almost universally, fast in speed and low in cost. Therefore, it is extremely easy for any user to get started with this sensor and achieve a very quick time to market.

Specifications

T_A = -45°C to 130°C, V_{CC} = 2.7V to 5.5V, unless otherwise noted.

Parameter	Min	Typ	Max	Unit	Conditions
Supply Voltage	2,7		5,5	V	
Active current ¹		50		μA	T _A = -45°C, V _{CC} = 2.7V, no load at the output pin
		60		μA	T _A = 25°C, V _{CC} = 3.3V, no load at the output pin
		70		μA	T _A = 25°C, V _{CC} = 5.5V, no load at the output pin
Average current		220		nA	T _A = 25°C, V _{CC} = 3.3V, one measurement per second
Power down current			0	μA	When controlling with V _{CC} pin
Accuracy TO18			0,25 ²	°C	-10 °C to 100 °C
			0,8 ²	°C	-45 °C to 130 °C
			0,1 ³	°C	-20 °C to 80 °C (second order interpretation)
			0,4 ³	°C	-45 °C to 130 °C (second order interpretation)
Accuracy TO92/TO220 SOT223			0,35 ²	°C	-10 °C to 100 °C
			1 ²	°C	-45 °C to 130 °C
			0,25 ²	°C	-20 °C to 80 °C (second order interpretation)
			0,8 ²	°C	-45 °C to 130 °C (second order interpretation)
time of measurement		1,8		ms	T _A = 25°C, V _{CC} = 3.3V, 8 periods
Noise ⁴			<0.0002	°C	T _A = 25 °C, V _{CC} = 5 V, 1 s measurement time
Output Duty Cycle	0,11		0,93		-45°C to 130°C
Output frequency	0,5		7	kHz	1 - 4 kHz for V _{CC} = 4.7-5.5 V and T _A = -25°C to 110°C
PSRR at V _{CC}			0,1	°C/V	
Repeatability ⁵			0,01	°C	T _A = 25°C, V _{CC} = 5V, TO18
Startup time		1	2	ms	after V _{CC} , start measurement on first negative edge
Long term drift			0,0058	°C	T _A = 22°C, V _{CC} = 5V, 365 days, TO18
Output impedance			100	Ω	by design
Operating Temperature	-45		130	°C	
Storage Temperature	-50		150	°C	
First order relation between Duty Cycle and temperature :					T = 212.77 DC - 68.085
Second order relation between Duty cycle and temperature :					T = -1.43 DC² +214.56 DC - 68.6

¹: Continuous conversion.

²: All error included, based on moving average of 80 valid duty cycles.

³: ±3σ value. For this accuracy, second order interpretation between Duty Cycle and temperature is used, where a valid Duty Cycle is based on the averaged value of 8 successive periods.

⁴: Noise level will be reduced by averaging multiple consecutive measurements. For instance, noise can be reduced to 0.0004°C and 0.0002°C by taking average in 0.1s and 1s, respectively. Measurement time should always be provided when noise is mentioned. The lower limit of the noise is determined by the flicker noise of the sensor, where further averaging will no longer reduce the noise.

⁵: Repeatability is defined as difference between multiple measurements on the same temperature point during multiple temperature cycles.



Absolute Maximum Rating

$T_A=25^{\circ}\text{C}$. All voltages are referenced to GND, unless otherwise noted.

Power supply voltage	-0.5V to 7V
Output pin load	50mA
Operating temperature range	-55°C^1 to 135°C
Storage temperature range	-60°C to 150°C
ESD protection (HBM)	2000V
Junction temperature	200°C
Soldering temperature (SOIC, SOT)	260°C (10s)

¹: For the accuracy over the temperature range from -55°C to -45°C and from 130°C to 135°C , contact Smartec

Output Signal

According to tradition, the Smartec temperature sensors have a duty cycle (PWM) output that can be directly interfaced with a microcontroller without the use of extra components. The output is a square wave with a well-defined temperature-dependent duty cycle. In general, the duty cycle of the output signal is defined by a linear equation:

$$DC = 0.32 + 0.0047 \times T$$

where

DC = Valid Duty Cycle

T = Temperature in $^{\circ}\text{C}$

A simple calculation shows that, i.e. at 0°C , $DC=0.32$ (32%); at 130°C , $DC=0.931$ (93.1%).

The temperature is derived from the measured duty cycle by:

$$T = \frac{DC - 0.32}{0.0047} = 212.77 \times DC - 68.085$$

The frequency of the sensor output varies with the temperature and the supply voltage, but it does not contain temperature information. Only the duty cycle contains temperature information in accordance to the formula given above.

A higher accuracy can be achieved when a second order formula is used, an accuracy of $\pm 0.1^{\circ}\text{C}$ can be achieved in the range of -20°C to 60°C .

Valid Duty Cycle

A valid duty cycle in equation (1) is defined as the average of individual duty cycles from 8 consequent output periods. This is due to the internal working principle of the SMT172 sensor. In order to eliminate the error caused by component mismatching, DEM (Dynamic Element Matching) has been applied in SMT172. A complete DEM cycle consists 8 periods. There might be large variation between each individual period, and this variation changes from sensor to sensor, but the averaged value of 8 consequent periods (**valid duty cycle**) is very stable and precise.



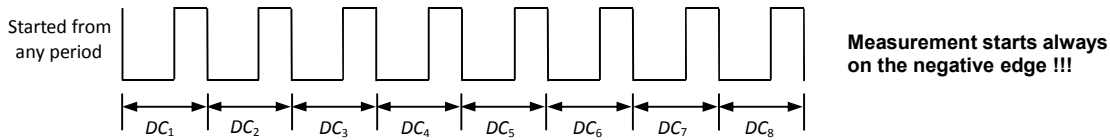

Therefore, a valid duty cycle is: $DC = \frac{\sum_{i=1}^8 DC_i}{8}$

$DC_i = \frac{t_{Hi}}{t_{Li} + t_{Hi}}$ Where t_{Hi} = time interval of high state
 t_{Li} = time interval of low state
 DC_i = duty cycle of individual period i
 DC = the valid duty cycle

The specified accuracy and noise performance are based on a measurement of 8 periods. For improved noise performance, measurement of multiples (N times) of 8 periods is recommended.

In other words:

After each period the duty cycle has to be calculated and stored. The mean duty cycle has to be taken over 8 periods or a multiple of 8 periods. This mean duty cycle is used to calculate the temperature. Measurement always starts on the negative edge of the output signal.

Understanding the specifications

Sampling Noise

From the theory of signal processing it can be derived that there is a fixed ratio between the frequency of the sensor output, the sampling rate and the sampling noise. The uncertainty of the temperature measurement is determined by:

$$T_{err} = 200 \frac{t_s}{\sqrt{6 t_m t_p}}$$

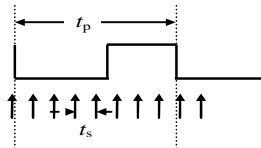

Where T_{err} = measurement uncertainty of temperature
 (= standard deviation of the sampling noise)
 t_s = microcontrollers sampling rate
 t_p = period of the sensor output
 t_m = total measurement time, an integer number of t_p

Note:

The above mentioned error T_{err} is NOT related to the intrinsic accuracy of the sensor. It just indicates how the uncertainty (standard deviation) is influenced when a microcontroller samples a time signal.



Sensor noise

Each semiconductor product generates noise, also the SMT172 sensor. The lower limit of the noise is determined by the flicker noise of the sensor, where further averaging will no longer reduce it. So the measured noise of the sensor mainly depends on the measurement time. The noise of the sensor is about 0.002°C when measuring over 3.6ms (8 periods, 5V). When measuring over about 1s the sensor noise is reduced to <0.0002°C.

Package induced error

When applying high stress package materials, extra errors will occur and therefore system designers should be aware of this effect. The TO-18 package has the minimum package induced errors. All other packages can have a slightly bigger error on top of the error in the specifications but based on the recent measurements on the plastic versions TO92, SOIC, SOT223 and TO220 the error will be less than ±0.35°C (-10°C to 100°C) and ±1°C over the temperature range of -45°C to 130°C.

Long-term drift

This drift strongly depends on the operating condition. The measured hysteresis in a thermal cycle (TO-18 packaged samples) is less than ±0.02°C over the whole temperature range. Even at extreme condition (TO-18 samples heated up to 200°C for 48 hours), the drift is still less than ±0.05°C over the whole temperature range (-45°C to 130°C). At room temperature (22°C), the output drift is less than 5.8mK over 365 days.

Typical Performance Characteristics

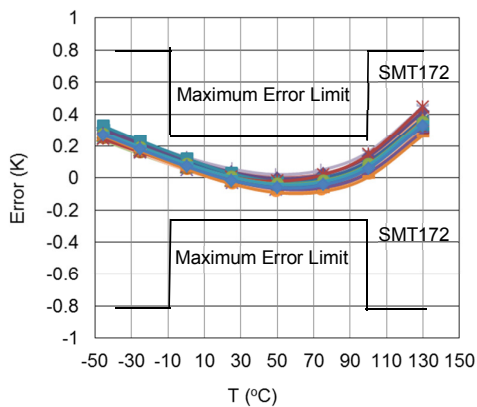

Accuracy vs. Temperature (TO18 $V_{CC}=5V$)

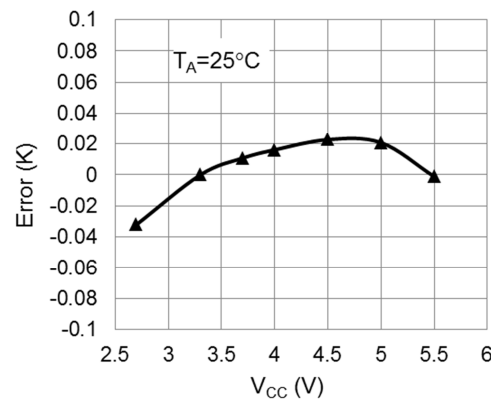

Normalized Error vs. Supply Voltage



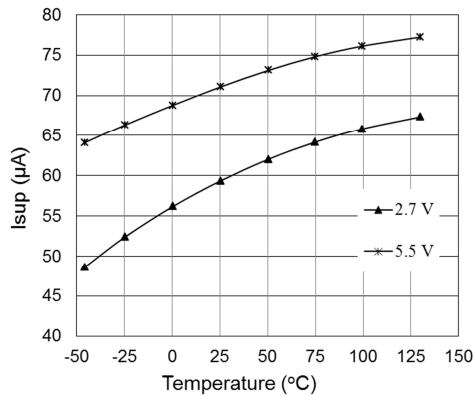

Supply Current vs. Temperature

Measurement with improved accuracy

This part of the datasheet of the SMT172 provides information how a temperature can be measured with a higher accuracy than what is specified in the datasheet.

How about

There are two reasons why the accuracy of $\pm 0.25^\circ\text{C}$ (-10°C to 100°C) has been specified in SMT172:

1. A linear equation, which is compatible with SMT160 has been used for duty cycle versus temperature. Higher order system errors remain.
2. Due to the special design skill, one complete measurement is the average of 8 periods (or a multiple of 8 periods). The specified accuracy in the datasheet is valid for all kinds of averaging methods.

If a more accurate measurement is required, a more sophisticated interpretation of the output signal is needed.

The better accuracy can only be achieved when:

1. Equation (2) is applied to obtain the valid duty cycle,
2. A second order equation is applied to translate the valid duty cycle to a temperature:

$$T = -1.43DC^2 + 214.56DC - 68.60$$

This second order equation can better interpret the valid duty cycle to temperature, and thus a more accurate result can be achieved. The equation corrects for the typical error curve versus the temperature as in the graph on the previous page.



Performance characteristic

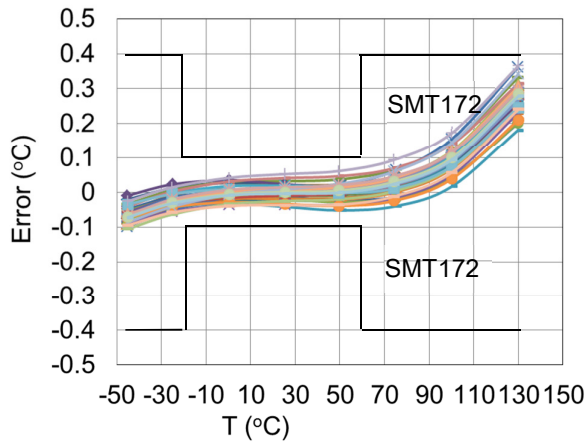

Accuracy vs. temperature ($V_{CC}=5V$, TO18)

Application Information

Temperature measurement

The SMT172 measures the temperature of its bipolar transistors with high precision. Due to the great thermal conducting property of single crystalline silicon, we can assume the temperature difference within the sensor die to be negligible. However the thermal property of the package material, the shape and the size of soldering pads, the neighbouring components on the PCB as well as the presence of dedicated thermal sinks are all affecting the die temperature that the sensor is measuring. Therefore a good thermal path between the die and the object under measurement should be carefully designed and considered.

When measuring temperature of solid or liquid targets, it helps to have a good thermal contact between the sensor and the target. This can be achieved with metals and thermal paste. When measuring air temperatures, it is important to isolate the sensor from the rest of the measurement system, so that the heating from the surrounding circuit components has only a small influence on the sensor temperature.

Self-Heating

All electronic circuits consume power, and all power becomes heat. Depending on the thermal resistance to the environment and the related thermal mass on the heat path, this heat will cause an extra temperature rise of the sensor die and will influence the final reading. Although the ultra-low power consumption of SMT172 sensor minimizes this effect greatly, it is always important to take this into account when designing a temperature measurement system. Design considerations like optimal thermal contact with the environment and powering down the sensors whenever possible (see SMTAS08) are all useful techniques to minimize this effect.

Thermal response time

The thermal response time of the temperature sensor is determined by both the thermal conductance and the thermal mass between the heat source and the sensor die. Depending on the packaging material and the immersing substances, this can vary in a wide range from sub-second to hundreds of seconds. The following table illustrates the time constant (the time required to reach 63% of an instantaneous temperature change) of TO-18 packaged sensors.



Conditions of installation	Time constant (s) (T0-18)
In an aluminium block	0.6
In a bath filled with oil that is stirred constantly	1.4
In air that moves at 3m/s:	
- Without heat sink	13.5
- With heat sink	5
In non-moving air:	
- Without heat sink	60
- With heat sink	100

Supply voltage decoupling/cable compensation

It is common practice for precision analogue ICs to use a decoupling capacitor between V_{cc} and GND pins. This capacitor ensures a better overall EMI/EMC performance. When applied, this capacitor should be a ceramic type and have a value of approximately 100nF. The location should be as close to the sensor as possible. The SMT172 has a very accurate output, the positive and negative edges of the output signal are very steep, about 5ns. This means when using longer cables (over 30cm) there can be an effect of the cable inductance and capacitance which means the pulse is “reflected” and will give a spike on the sensors power supply line and the output of the sensor. These spikes can damage the electronics behind this and also the sensor. Therefore we also advise user to put in series with the V_{cc} line a resistor of 100Ω. This resistor can also damp the spikes on the signal as well on the V_{cc} line when user forget to apply decoupling capacitor (this helps only for short cable <1m).

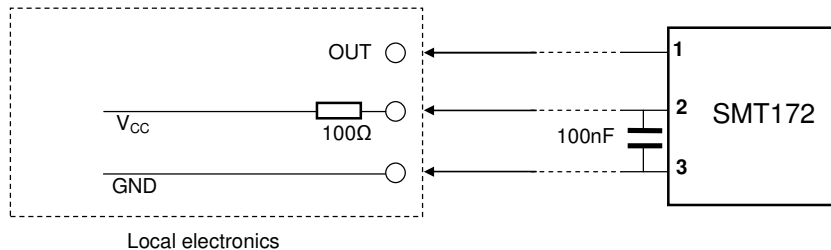

The capacitor will enhance the EMC performance and the resistor will also limit the maximum current in case of faults or wrong connections.



Packaging :

SOIC-8L

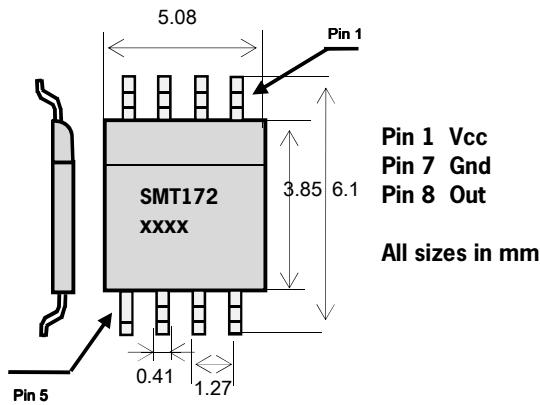

T0220

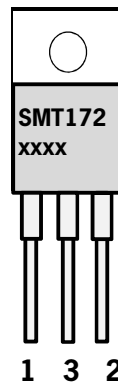

metal backplate = GND

T092

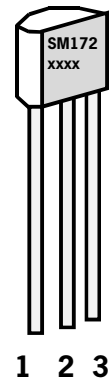

HEC

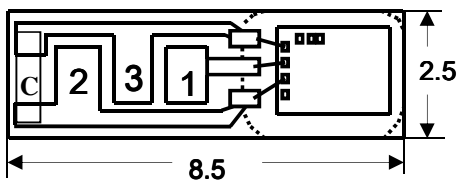

- 1 Output
- 2 + Vcc
- 3 GND

bottom view

T018

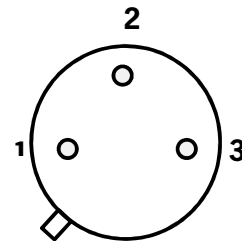

SOT223

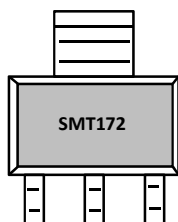

- 1 2 3
- 1 Vcc
- 2 Gnd/heatsink
- 3 Out



Ordering code:

SMT172-SOT223	SMT172 in SOT223 encapsulation
SMT172-T018	SMT172 in TO-18 encapsulation
SMT172-T092	SMT172 in TO-92 encapsulation
SMT172-T0220	SMT172 in TO-220 encapsulation
SMT172-SOIC	SMT172 in SOIC-8 encapsulation
SMT172-HEC	SMT172 in HEC encapsulation
SMT172-DIE	SMT172 DIE (die size 1.7 x 1.3 mm)

Related products:

SMTAS04USBmini	evaluation board for 4 sensors input (USB connection)
SMTAS08USBmini	evaluation board for 8 sensors input (USB connection)
SMT172 to IIC	converts SMT172 signal to I ² C signal (or to SMT160 signal)
SMTRVS1802	4.5 mm ss. probe with SMT172 TO18 sensor and 5 meter shielded cable

sales@smartec-sensors.com

