

UP-PW1245P

DIMENSIONS (MM)

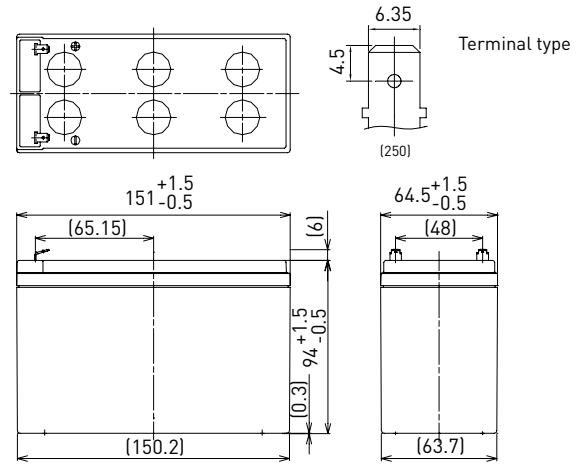

FOR STANDBY POWER SUPPLIES.
EXPECTED TRICKLE DESIGN LIFE: 10 - 12 YEARS AT 20°C
ACCORDING TO EUROBAT.



Contents indicated (including the recycle marking, etc.) are subject to change without notice.

Battery case resin: flame retardant (UL94 V-0)

SPECIFICATIONS		
Name	UP-PW1245P1	
Nominal voltage	12V	
Rated power (cell@10MR)	270W	
Dimensions	Length	151mm
	Width	64.5mm
	Height	100mm
Approx. mass	2.55kg	
Terminal	Faston 250	
Capacity (25°C)	30 minute rate	112W
	15 minute rate	195W
	10 minute rate	270W
	5 minute rate	410W
Impedance	Fully charged battery (25°C)	20mΩ
Temperature dependency of capacity (20 hour rate)	40°C	102%
	25°C	100%
	0°C	85%
	-15°C	65%
Self-discharge (25°C)	After 3 month	91%
	After 6 month	82%
	After 12 month	64%

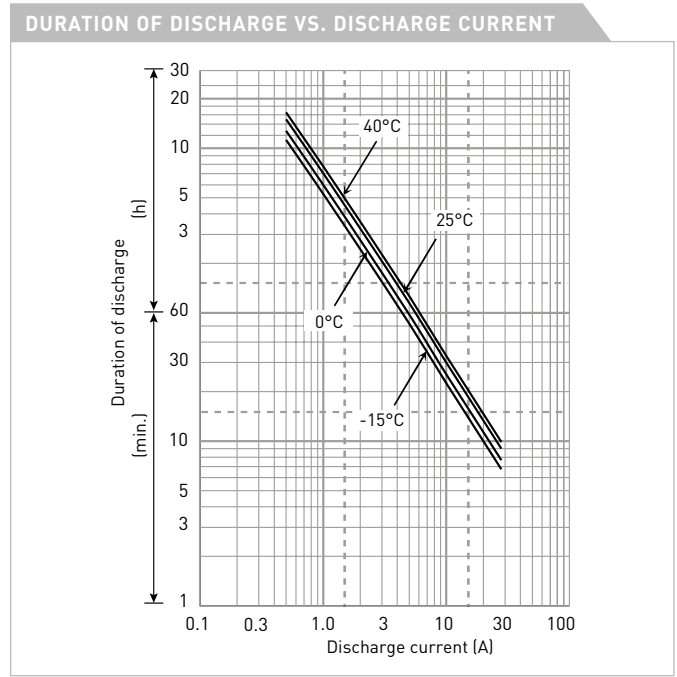

WATT TABLE (25°C)																(Wattage/battery)
Cut-off	3min.	5min.	10min.	15min.	20min.	30min.	45min.	1h	1.5h	2h	3h	4h	5h	6h	10h	20h
9.6V	530	410	270	195	159	112	82.1	65.7	45.2	34.9	26.0	20.0	16.5	13.3	8.79	4.76
9.9V	509	400	263	194	158	111	81.6	65.1	44.3	34.7	25.9	19.8	16.4	13.2	8.75	4.75
10.2V	490	390	258	193	156	110	80.8	64.4	43.4	33.9	25.6	19.7	16.2	13.1	8.65	4.73
10.5V	463	360	246	187	151	109	78.7	63.0	41.7	32.8	25.2	19.5	16.1	13.0	8.62	4.72
10.8V	434	330	234	180	146	108	78.3	61.8	41.3	31.1	24.7	19.3	15.7	12.7	8.52	4.69

AMPERE TABLE (25°C)																(Ampere/battery)
Cut-off	3min.	5min.	10min.	15min.	20min.	30min.	45min.	1h	1.5h	2h	3h	4h	5h	6h	10h	20h
9.6V	47.7	36.8	23.9	17.0	13.7	9.57	6.99	5.57	3.82	2.95	2.19	1.67	1.38	1.11	0.732	0.397
9.9V	45.8	35.9	23.5	16.9	13.6	9.55	6.95	5.50	3.75	2.93	2.17	1.66	1.37	1.10	0.729	0.396
10.2V	44.1	35.0	23.0	16.8	13.5	9.49	6.88	5.46	3.67	2.86	2.15	1.65	1.36	1.09	0.721	0.394
10.5V	41.6	32.3	22.0	16.3	13.0	9.40	6.70	5.35	3.53	2.77	2.11	1.64	1.35	1.08	0.718	0.393
10.8V	39.0	29.6	20.9	15.7	12.6	9.32	6.67	5.25	3.50	2.62	2.08	1.62	1.31	1.06	0.710	0.391

All mentioned values are average values

UP-PW1245P

CHARGING METHOD (25°C)

Trickle use Control voltage: 13.6V - 13.8V
Initial current: 1.2A or smaller

CUT-OFF VOLTAGE

Discharge current	0.4A - 1.6A	1.6A - 4A	4A - 8A	8A - 16A	16A - 24A
Cut-off voltage	10.5V	10.2V	9.9V	9.3V	8.7V

INFLUENCE OF TEMPERATURE ON TRICKLE LIFE

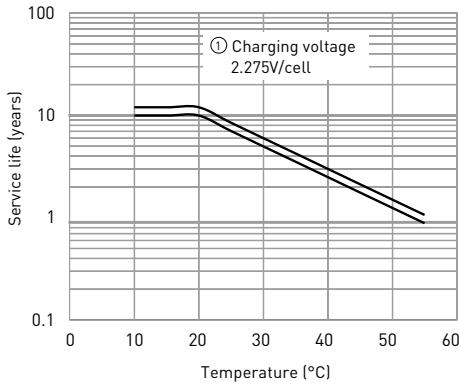

RESIDUAL CAPACITY TEST RESULT

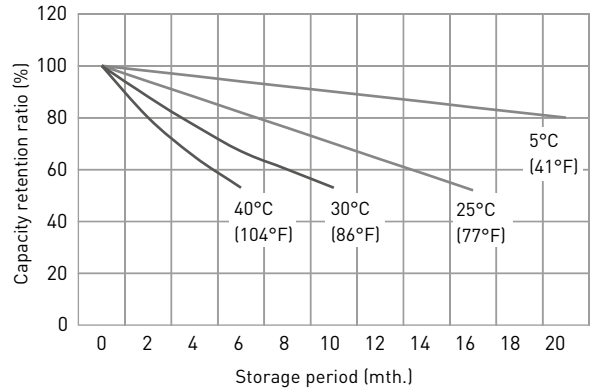

CONSTANT-VOLTAGE CONSTANT-CURRENT CHARGE CHARACTERISTICS FOR TRICKLE USE

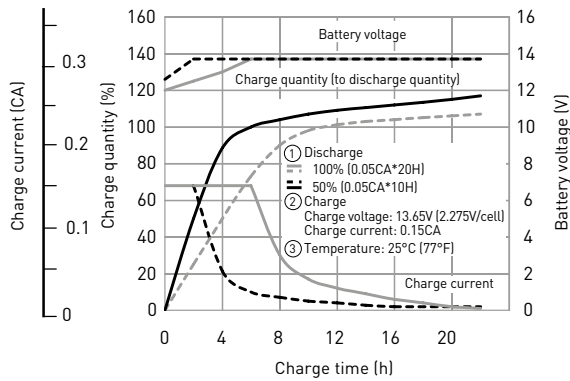

DISCHARGE CAPACITY BY TEMPERATURE AND BY DISCHARGE CURRENT

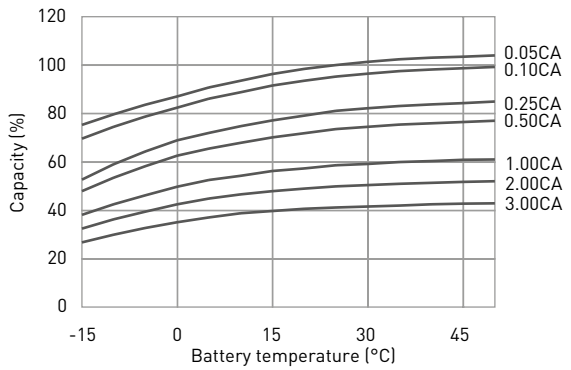

DISCHARGE CHARACTERISTICS

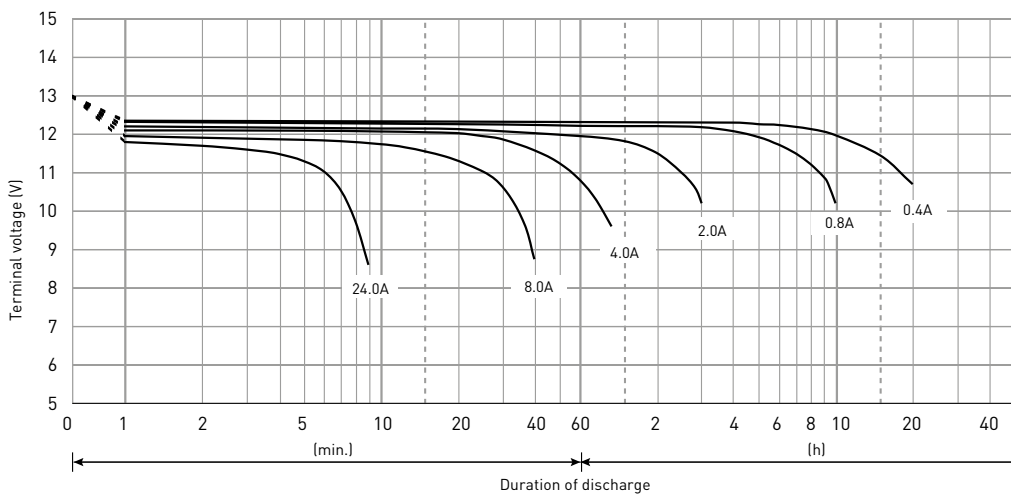

The data in this document are for descriptive purposes only and are not intended to make or imply any guarantee or warranty. Regarding handling and safety please consult our VRLA technical handbook chapter 1.